

PROGRESSION - FULL GRP COVER

Drawing Title: Progression windows opening and fixed (ALL).dwg
 General Notes:
 DO NOT SCALE
 Retention of Copyright: Environmental Construction Products Ltd retain the copyright of this document. Environmental Construction Products Ltd license the Purchaser to use and copy this document only for the Purchaser's own purposes subject to our Standard Conditions of Sale and to payment of all invoices according to agreed terms

(ALL).dwg

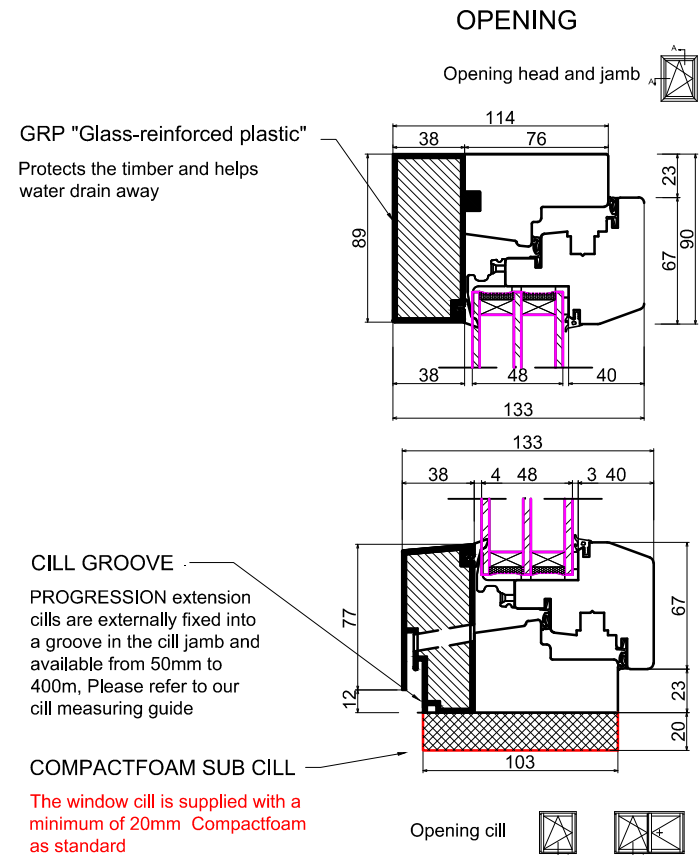

GRP "Glass-reinforced plastic"
 Protects the timber and helps water drain away

CILL GROOVE
 PROGRESSION extension cills are externally fixed into a groove in the cill jamb and available from 50mm to 400m, Please refer to our cill measuring guide

COMPACTFOAM SUB CILL
 The window cill is supplied with a minimum of 20mm Compactfoam as standard

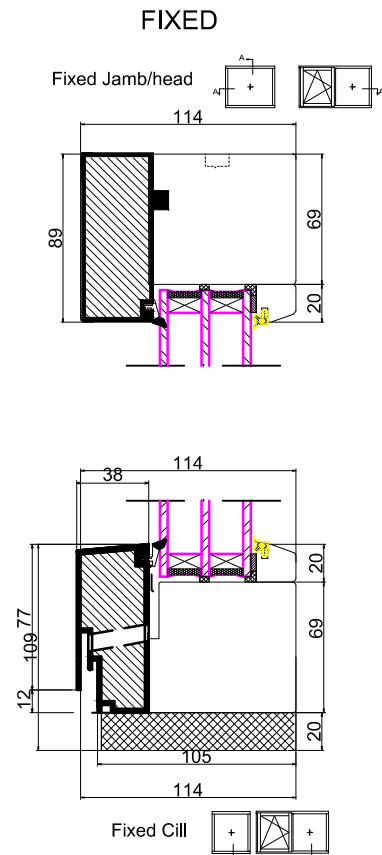

CORNER POST DETAIL

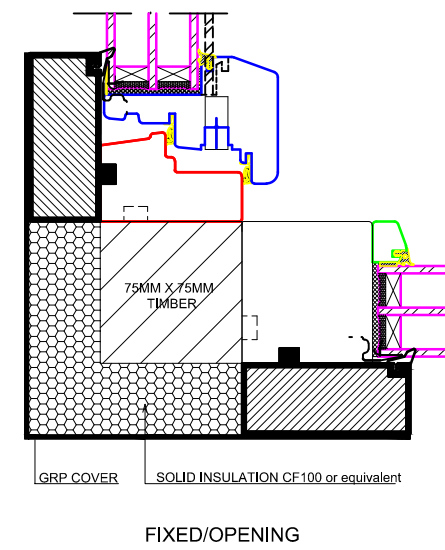

Mullion Fixed/Fixed

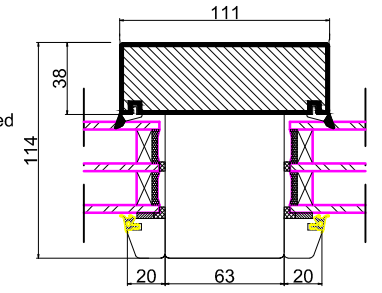
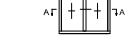

Mullion Open/Fixed

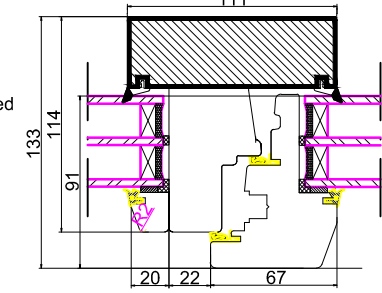
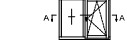

Floating Mullion

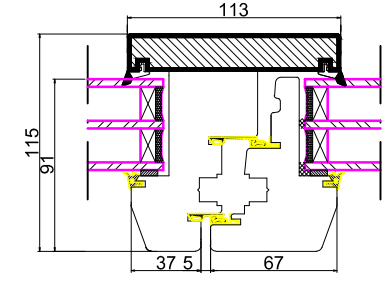
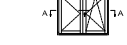

Mullion open/open

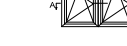

*Integrated frame

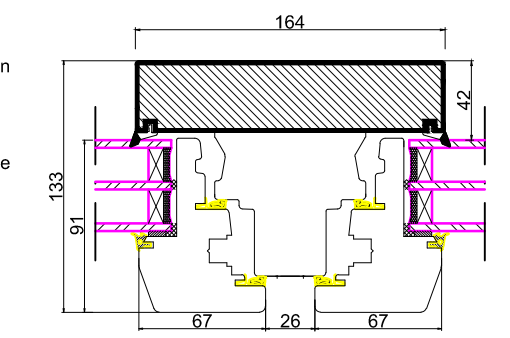

Mullion open/open



*Two frames joined to create mullion

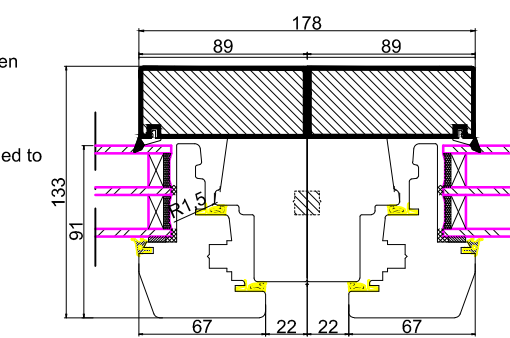

PLEASE NOTE: 15MM EXTENDED JAMB OPTION

The head and side Jamb can be extended 15mm to allow for more internal space for finishing/plasterboard and clearance for the opening sash
 22mm clearance would be required as shown on the install example to the right

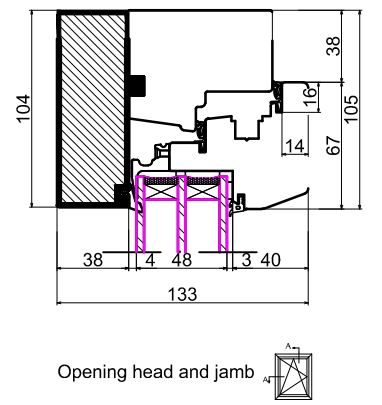

BASIC PLYWOOD BOX JAMB INSTALL/TAPING DETAIL

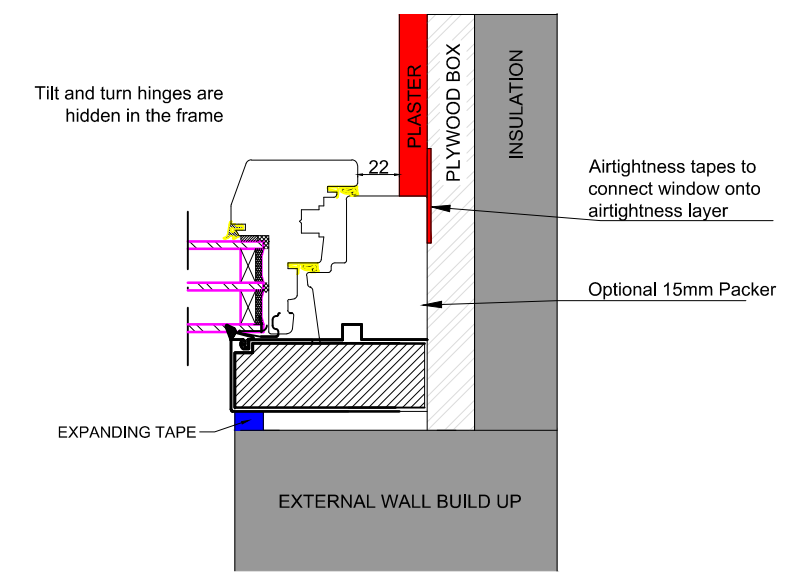

FOR FURTHER INFORMATION OR DETAILING ADVICE PLEASE REFER TO PROGRESSION GUIDANCE DOCUMENT OR CONTACT THE WINDOWS OFFICE

Drawing Title: Progression windows opening and fixed (ALL).dwg		Last Updated: 15/ 9/ 2020		A3	LS
	Making buildings better Products and support for energy efficient homes and buildings		Contact us: Phone: 01484 463336 Web : www.greenbuildingstore.co.uk Email: windows@greenbuildingstore.co.uk		Green Building Store Heath House Mill Heath House Lane Golcar, Huddersfield West Yorkshire HD7 4JW
	Social:				
	Environmental Construction Products Ltd retain the copyright of this document. Environmental Construction Products Ltd license the Purchaser to use and copy this document only for the Purchaser's own purposes subject to our Standard Conditions of Sale and to payment of all invoices according to agreed terms				
	DO NOT SCALE				

(ALL).dwg